

Data Sheet



Article number: 20343132M10KRE

Description: E+G levelling foot
GN 343.1-32-M10-KRE

Measures

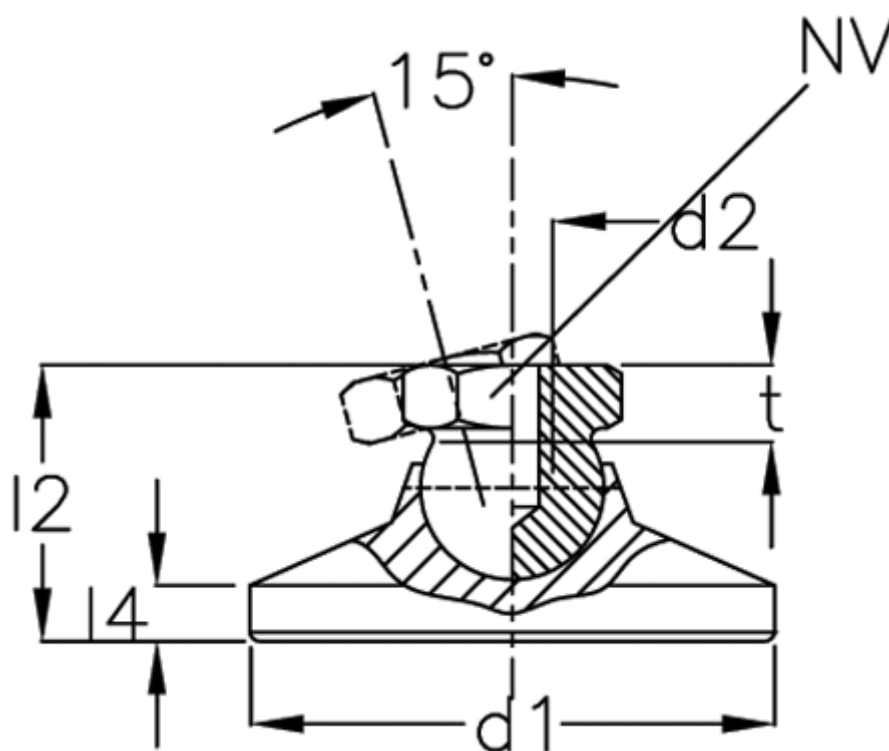

d1	= 32
d2	= 10
l2	= -
l4	= -
NV	= 15
Static load (kN)	= 20
t min	= 10.5